

# Machine Accessories

**X-FLOC**  
Pneumatic Insulation Technology



# Radio Remote Control FFB2000-Pro

The machine type M99-DS-Pro and M99-DS-Pro 8K is supplied as standard with a specially developed radio remote control FFB2000-Pro. All important settings and functions can be comfortably controlled from the operator's workplace. The air power and the material flow volume can be adjusted in 19 levels during operation or in standstill.



In case of a radio interference, the operation can be established by connecting the hand-held transmitter and the receiver with a supplied connection cable.

Together with the insulation blowing machine's integrated pressure detection unit, special functions such as the „Dynamic Pressure Control“ and „Automatic Shutdown“ can be used.

**Note:** The machine is backward compatible with the control FFB2000 and KFB2000 with some function restrictions.

**KFB2000**  
(Art.-Nr. 1497)



Bidirectional digital wireless technology



Four radio channels for construction sites with interference sources



In case of overpressure acoustic warning signal

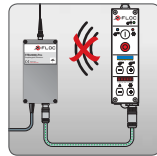

Cable control possible

## Dynamic Pressure Control

The dynamic pressure control function limits the maximum injection pressure to a pre-set value. For this purpose, the pressure threshold has to be set to the desired maximum allowable pressure on the machine. In injection mode, the pressure is now reliably limited when the set threshold value will be reached. The control mechanism can be activated by means of a key combination on the hand-held control of the cable or radio remote control and is indicated by a flashing of the current air flow setting.

### Typical applications:

- ▶ Injection of air-tight elements with the risk of damage to the planking materials
- ▶ Reduction of the bulging of thin planking materials
- ▶ Avoiding local areas with high density when blowing roof elements

## Automatic Shutdown

The function of the automatic shutdown enables an automatic switch off of the machine when a selected pressure threshold value is reached. For this purpose, the setting of the pressure threshold value has to be set to the desired value on the machine and the function has to be activated on the hand-held control. The machine will switch off automatically if the pressure threshold value will be reached (response time can be set with parameters) without additional user intervention.

### Typical Applications:

- ▶ Assistance while injecting with automated shutdown if the threshold value is exceeded
- ▶ Achieve reproducible injection processes by pressure-based shutdown procedures
- ▶ Independent shutdown when filling insulation materials

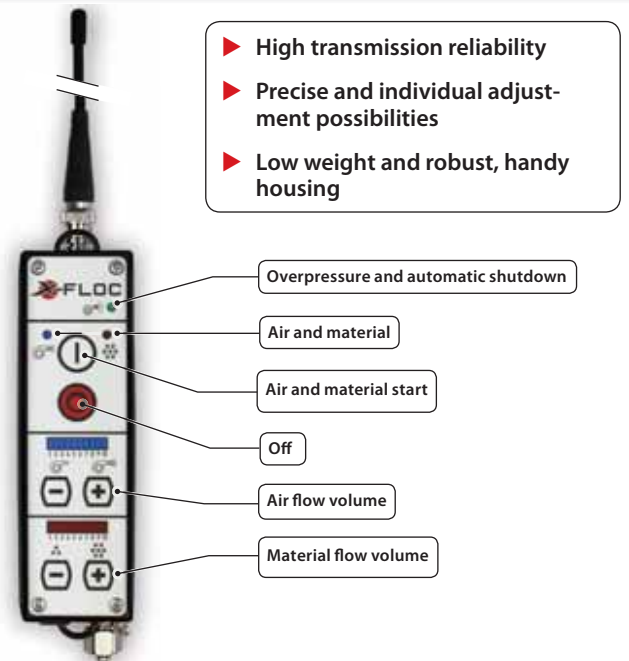

- ▶ High transmission reliability
- ▶ Precise and individual adjustment possibilities
- ▶ Low weight and robust, handy housing

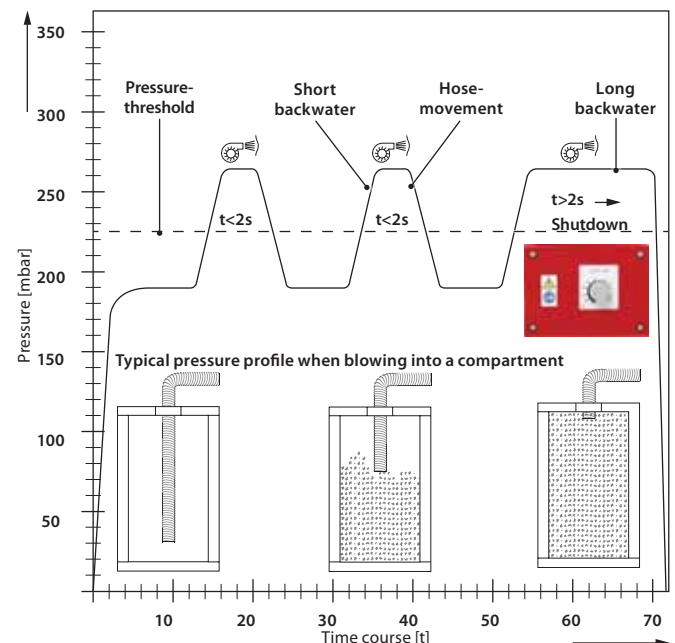
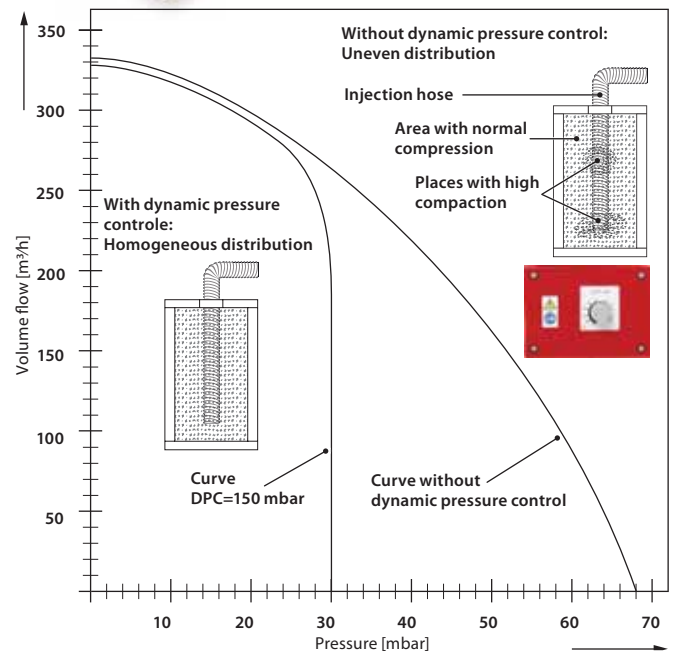

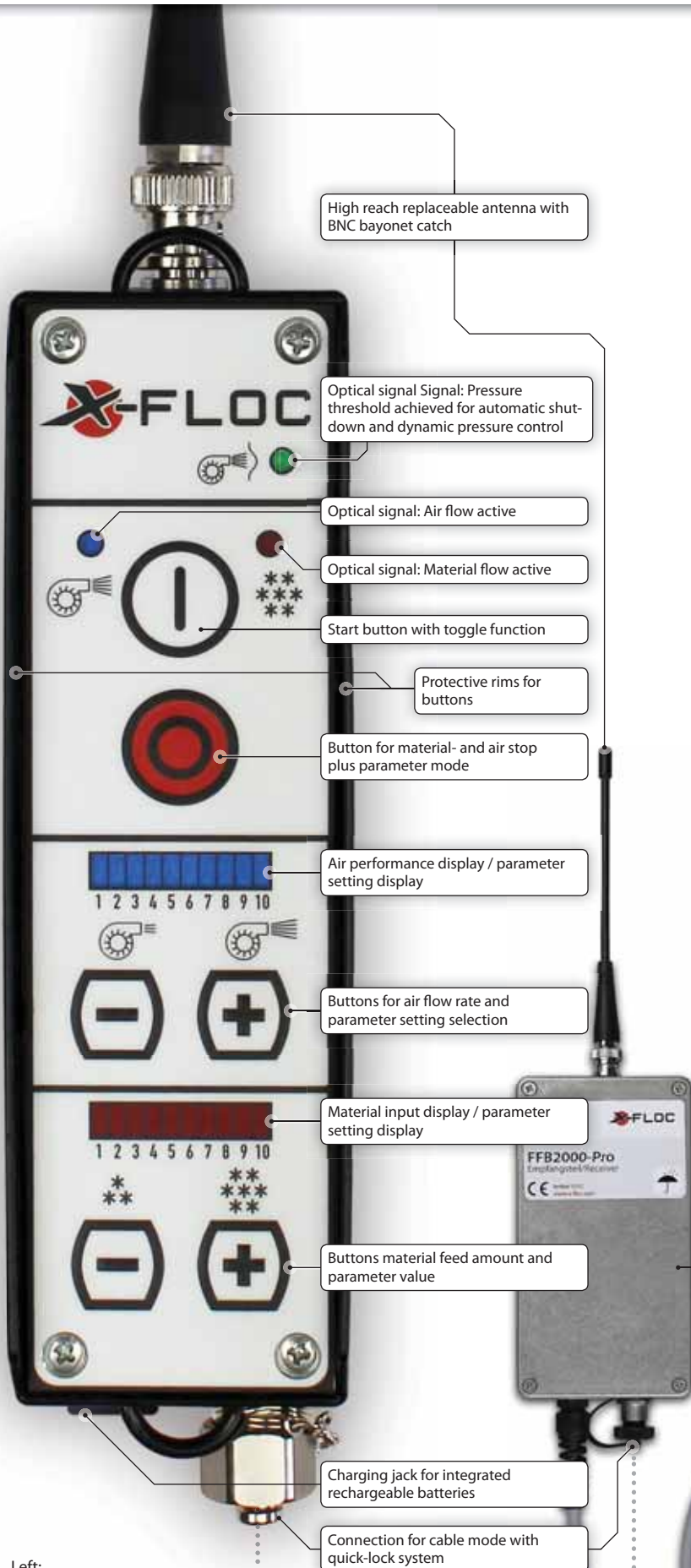

Technische Daten	
Übertragungsfrequenz	434 MHz
Arbeitstemperaturbereich	-20°C bis +40°C
Versorgungsspannung	24V DC
Handbedienteil	
Nutzungsdauer	bis zu 30 h
Reichweite	> 100 m im freien Feld
Überdrucksignal	▶ LED (optisch) ▶ Warnton (akustisch)
Funktionstasten	6 (Folientastatur)
Parameterstufen	10
Verstellbare Parameter:	
Funkkanäle	1 - 4
Einschaltverzögerung Material	0, 1, 2,... 9 s
Ausschaltverzögerung Luft	0, 1, 2,... 9 s
Verzögerungszeit autom. Abschaltung	0, 1, 2,... 9 s
Reaktionszeit der dyn. Druckstrg.	50, 100,... 500 ms
Schutzart	IP40
Anschlüsse	▶ Kabelsteuerung ▶ Ladebuchse ▶ Antenne
Stromversorgung	3x AAA NiMH 800mAh
Gewicht	ca. 400 g
Abmessungen	ca. 47 x 154 x 47 mm
Empfangsteil	
Schutzart	IP40
Anschlüsse	▶ Steuerleitung zur Maschine ▶ Kabelsteuerung ▶ Antenne
Stromversorgung	24VDC (Von Einblasmachine)
Gewicht	ca. 765 g
Abmessungen	ca. 83 x 151 x 50 mm
Artikelnummer	5154

Left:  
remote control;  
right: receiver

Optional cable connection

# Controls

## Radio Remote Control FFB5000

The machine type M99-DS is supplied as standard with a specially developed radio remote control FFB500.

The radio contact takes place with a secure, bidirectional communication between hand-held transmitter and receiver. Several frequency channels are available. The transmission and receive power will increase automatically at longer distances.

If the range will be exceeded or in case of radio contact loss, the machine will be switched off automatically. The robust hand-held transmitter can be easily secured by a loop for wrist strap. The control elements can be locked against unintentional activation.

The most important commands can be transmitted to the insulation blowing machine with the hand-held transmitter:

- ▶ Air start
- ▶ Material start
- ▶ Combined start of air and material with adjustable time delay
- ▶ Stop

**Note:**

The radio remote control is compatible with many third-party products. The controls can be used after adjustment of the connection with machines of e.g. Krendl, Thermoblow, SHS, Isoblow, etc.

- ▶ Low weight and robust, handy housing
- ▶ Bidirectional wireless technology
- ▶ Multiple frequency channels
- ▶ Range monitoring with safety shutdown in case of overrun
- ▶ Automatic range increase, combined with increased power consumption if required

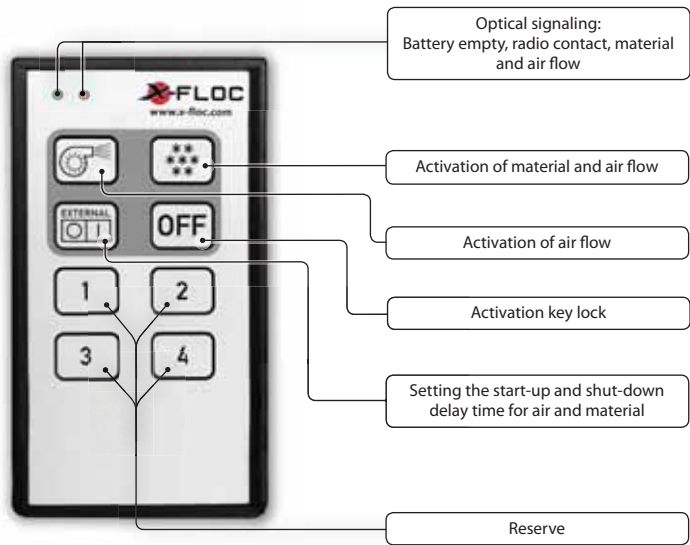

## Cable Controls

Type	Included in delivery	Options	Compatibility	Prod..
KFB3	Hand control with toggle switch	Extension control cable (Prod.No. 1882)	EMX90, EM100, M99, other machines	3821
KFB3 - 8p	Hand control with toggle switch	Extension control cable (Prod.No. 2015, 2166, 1987)	EMX90, EM100, M99, other machines	7851
KFB30	Hand control with toggle switch	Extension control cable (Prod.No. 1882)	EMX90, EM100, M99, other machines	2459
KFB30 - 8p	Hand control with toggle switch	Extension control cable (Prod.No. 2015, 2166, 1987)	EMX90, EM100, M99, other machines	7852
KFB2000	Cable control	-	M99-DS-Pro, M95, EM300, EM400, Turbofant M05, EM500	1497
3-channel M05	Hand control	-	other machines	4469
Master-Slave	Control side connection with 4-pin plug (on/off e.g. damp spraying pump)	-	M99, M95, Turbofant M05	1057
Attachment devices adapter EM100	For switching attachment devices, synchron to air performance	-	EM100	5436



## Accessories

Type	Length	Prod.
FFB2000-Pro connection cable	50m	5280
KFB30 extensionconnection cable	50 m on cable drum	1882
KFB2000 control cable	25 m	2015
	50 m	2166
	50 m	1987
	on cable drum	





- ▶ Impressive with big viewing glass
- ▶ House advertising possible as label
- ▶ Dust-free and quiet operating
- ▶ Simplest use
- ▶ Convenient for cellulose and wood fibre and free flowing bulk material

**Exhibition Model EM3XX and M95 Zellofant, prod. no. 3020**

Dimensions (L×W×H): 112×86×118 cm

Recommended accessories:

- ▶ Short hopper top piece for M95 Zellofant, Prod. no. 4812
- ▶ KFB control cable L=5 m , Prod. no. 1119

**Exhibition Model Compact M99 Minifant and M95 Zellofant, prod. no. 3132**

Dimensions (L×W×H): 75×58×77 cm

Recommended accessories:

- ▶ For M95 Zellofant connection set required, Prod. no. 6098
  - Adapter plate, Prod. no. 3135
  - 0.5 m conveyor hose NW75, Prod. no. 284
  - Reducer tube PE NW75>63 short, Prod. no. 3768
  - 2 hose clamps NW75, Prod. no. 177
- ▶ Short hopper top piece for M95 Zellofant, Prod. no. 4812
- ▶ KFB control cable L=5 m , Prod. no. 1119



Exhibition model EM3XX and M95 Zellofant

**Function Drawing**

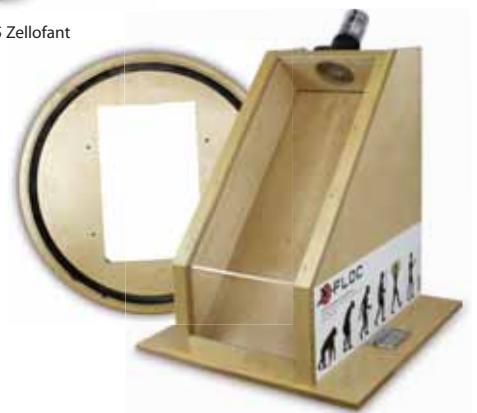
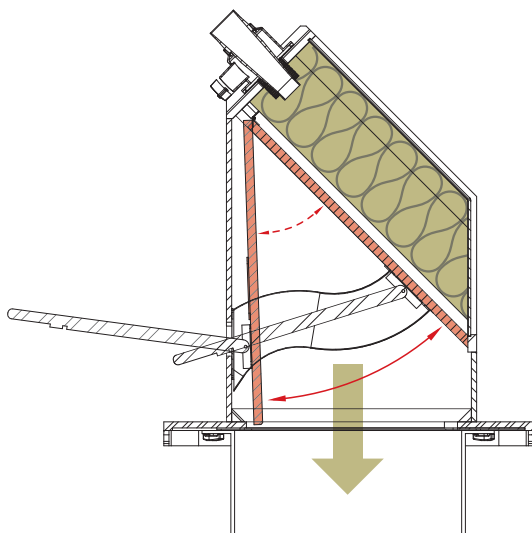

Exhibition model compact with adapter plate for M95 Zellofant

## Suction drums

Description	Volume	*** *** ***		Weight	D × H	Prod.No.
Suction drum V= 115L	115 L	NW75 (3")	NW75 (3")	ca. 20 kg	45 × 86 cm	1160
Suction drum V= 250L	250 L	NW75 (3")	NW75 (3")	ca. 31 kg	63 × 100 cm	3075

### Included in delivery:

- ▶ 5 × woven polypropylene sacks
- ▶ 1.5 m conveyor hose NW75 (3")
- ▶ 2 × quick-connect clamps NW75 (3")
- ▶ 1 × plastic reducer tube NW75>63

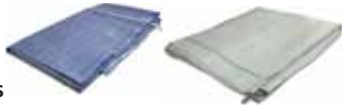

### Woven polypropylene sacks

Description	Size	blue/white	white	Prod. No.
Bag of woven polypropylene	100 × 150 cm	●	-	801
Bag of woven polypropylene	70 × 110 cm	-	●	1085



## Detention Grids

Retention grid for M99 hopper

Optional extra for processing free-flowing bulk materials. Prevents reaching into machine. Including fine-mesh insert.

**Prod. no. 2940**

Retention grid for M95 hopper

Optional accessory for processing loose bulkware. With a fine wire mesh for insertion into the hopper top piece.

**Prod. no. 2941**



Detention grid Minifant M99



Detention grid Zellofant M95

## Reducer/Extension Tubes

The reducer/extensions tubes are made of stainless steel. It is inserted in the airlock outlet of the insulation blowing machine. It makes connection of smaller or thicker hose diameters possible.

	Compatibility	Hose connection Ø	Prod. No.
<b>Extension Tubes</b>			
NW75>90	M95, EM300, EM400 + EM500	NW90 (3 1/2")	6746
<b>Reducer Tubes</b>			
NW75>63	M95, EM300, EM400 + EM500	NW63 (2 1/2")	526
NW75>50	M95, EM300, EM400 + EM500	NW50 (2")	1972
NW63>50	M99 + EM100	NW50 (2")	2862
NW63>38	M99 + EM100	NW38 (1 1/2")	6224



NW75>90



NW63>38



NW75>63



NW75>50



NW63>50

## Supports for bags

	Material	Support bracket	Dust-reducing cover	Prod. No.
EM100	Aluminium	●	-	4714
M99	Aluminium	●	-	3474
M95	Aluminium	●	-	4791
M95 with dust-reducing cover	Aluminium with cloth cover	●	●	3218
			+option low filling height	5128
M95 with dust-reducing cover	Wood	-	●	5786



Sack support EM100

Sack support M99

Sack support M95

Sack support M95 with dust-reducing cover



### Replacement Grid for M95

Replacement grid for cellulose, rock wool and similar, suitable for the zellofant M95. The new grid geometry allows for better material conditioning. The narrow mesh opening above the airlock prevents insufficiently shredded material from falling into the airlock. Mesh: 50 - 100 mm

**Prod. No. 4164**



### Electric Generator XE Exhaust Hose

Flexible metal hose for removal of exhaust gases. Length: 1.5 m

**Prod. No. 4800**

Also available:  
90° bend suitable for exhaust hose .

**Prod. No. 4801**



### Short Hopper top Piece

Shorter hopper top piece, suitable for M95 Zellofant.

Height: approx. 750 mm

Volume: approx. 0.3 m<sup>3</sup>

**Prod. No. 4812**



### Electric Generator XE10kW: Wheelset

- ▶ Easy mounting
- ▶ Without drilling

**Prod. No. 4982**



### Airlock Slide Gate for M95

The airlock slide gate enables precise adjustment with the material volume, thus achieving a constant material flow. Recommended for damp spraying.

**Prod. No. 3194**



### Electric Generator XE14 kW: Refuelling System

20 litre canister with fuel extraction device.

**Prod. No. 4802**

Also available:  
Replacement hose for refuelling system (prod. no. 5753)



### Emergency Stop Button with Casing for Plugging Into Remote Control Socket

Easy to install solution for immediate stoppage of the insulating machine. Suitable for all machines with KFB2000, FFB2000 or FFB2000-Pro remote control. Connected between remote receiver or cable and the remote socket at the machine. Due to a magnetic base, it can be installed at any point of the machinery case.

**Prod. No. 5863**



### Blow-Off Unit

Pressure control unit consisting of weighted pistons and air outlet holes in the cylinder. With the adjustable weighted discs, desired maximum pressure can be selected. Responsive pressure control. This is especially advantageous for pressure sensitive retaining board material and airtight constructions.

**Prod. No. 4038**



### Mains Voltage Display

Detects fluctuating or low voltage supplies. Suitable for use with the following machines:

- ▶ M99-Standard, M99-DS and M99-DS-Pro
- ▶ M95-230V, M95-2x230V
- ▶ EM320, EM325, EM345 and EM365
- ▶ EM440-400V und EM440-3x230V
- ▶ All single-phase insulation blowing machines and amplifiers etc.

**Prod. No. 4604**

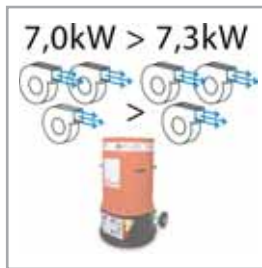

### Zellofant M95-400V-7.0kW Update to 7.3 kW - Var. 2

With this update, the air power of the machine is increased by 0.3 kW and distributes the connection load of the insulation blowing machine almost uniformly among the three phases of the three-phase connection.

**Prod. No. 6909**

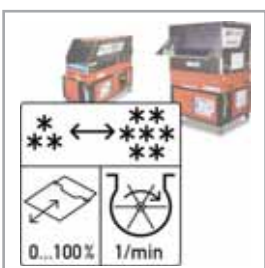

### Adjustable Airlock Rotation Speed (EM400/EM500)

Adjustable airlock rotation speed for the EM400/EM500 machine series Selectable by the Radio Remote Control FFB2000-Pro.

**Prod. no. 5060**



### Zellofant M95-400V-7.0kW Zellofant optional add-on – all blowers adjustable – Var. 3

With this additional option, the power of all three centrifugal fans of the insulation blowing machine can be adjusted with the control.

**Prod. no. 6937**



# „X-Floc Dämmtechnik-Maschinen GmbH, the brand for quality and innovation in the field of insulation technology.“

Since its founding in 1994, X-Floc Dämmtechnik Maschinen GmbH has been developing, manufacturing and selling insulation blowing machines and insulation accessories. Our typical customers are craft and assembly companies, such as carpentry and roofing companies, drywall builder and similar. Since 2014, we are manufacturing and supplying complete filling systems for prefabricators, which enable an efficient, industrial production of elements with injection insulation.

Since we develop our technology from the beginning together with our customers and the manufacturers of loose insulation materials, our products are compatible with almost all available injection products. This great innovative capacity, our variety of products and our much praised service have made us a worldwide recognized specialist in pneumatic conveying, especially for loose insulation material. This, our high quality standards and the lived „Made in Germany“ are the most important decision criteria of our customers.



**X-Floc Dämmtechnik-Maschinen GmbH**  
Rosine-Starz-Straße 12 · 71272 Renningen · Germany  
Telephone + 49 - 7159 - 80470 - 30 · Fax -40  
E-Mail [info@x-floc.com](mailto:info@x-floc.com) · Web [www.x-floc.com](http://www.x-floc.com)

Your X-Floc dealer